

SIG SAUER[®]
when it counts[®]

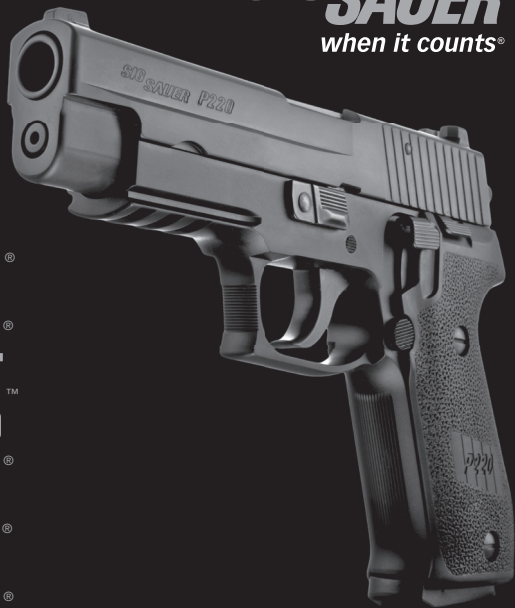

P220[®]
P224[®]
P225[™]
P226[®]
P227[®]
P229[®]
P239[®]

OWNERS MANUAL: HANDLING & SAFETY INSTRUCTIONS

READ THE INSTRUCTIONS AND WARNINGS IN THIS MANUAL CAREFULLY BEFORE USING THIS FIREARM; DO NOT DISCARD THIS MANUAL.

This instruction manual should always accompany this firearm and be transferred with it upon ownership, or when the firearm is loaned or presented to another person.

State-By-State Warnings

Certain states require, by law, that their own specified warning notices, in larger-than-normal type be conspicuously included by the manufacturer, distributor, or retail dealer with firearms sold in that state. SIG SAUER sells its products in compliance with applicable laws and regulations. Because our products may be sold in these states, we include the following:

CALIFORNIA:

WARNING

"Children are attracted to and can operate firearms that can cause severe injuries or death. Prevent child access by always keeping guns locked away and unloaded when not in use. If you keep a loaded firearm where a child obtains and improperly uses it, you may be fined or sent to prison."

ADVERTENCIA

"A los niños atraen las armas de fuego y las pueden hacer funcionar. Ellos pueden causarse lesiones graves y la muerte. Evite que los niños tengan acceso a las armas de fuego guardándolas siempre con llave y descargadas cuando no las esté utilizando. Si usted tiene una arma de fuego cargada en un lugar en que un niño tiene acceso a ella y la usa indebidamente, le pueden dar una multa o enviarlo a la cárcel."

CONNECTICUT:

"UNLAWFUL STORAGE OF A LOADED FIREARM MAY RESULT IN IMPRISONMENT OR FINE."

FLORIDA:

"IT IS UNLAWFUL, AND PUNISHABLE BY IMPRISONMENT AND FINE, FOR ANY ADULT TO STORE OR LEAVE A FIREARM IN ANY PLACE WITHIN THE REACH OR EASY ACCESS OF A MINOR UNDER 18 YEARS OF AGE OR TO KNOWINGLY SELL OR OTHERWISE TRANSFER OWNERSHIP OR POSSESSION OF A FIREARM TO A MINOR OR A PERSON OF UNSOUND MIND."

MAINE:

"ENDANGERING THE WELFARE OF A CHILD IS A CRIME. IF YOU LEAVE A FIREARM AND AMMUNITION WITHIN EASY ACCESS OF A CHILD, YOU MAY BE SUBJECT TO FINE, IMPRISONMENT OR BOTH. KEEP FIREARMS AND AMMUNITION SEPARATE. KEEP FIREARMS AND AMMUNITION LOCKED UP. USE TRIGGER LOCKS."

MARYLAND:

"WARNING: Children can operate firearms which may cause death or serious injury. It is a crime to store or leave a loaded firearm in any location where an individual knew or should have known that an unsupervised minor would gain access to the firearm. Store your firearm responsibly!"

MASSACHUSETTS:

"WARNING FROM THE MASSACHUSETTS ATTORNEY GENERAL: This handgun is not equipped with a device that fully blocks use by unauthorized users. More than 200,000 firearms like this one are stolen from their owners every year in the United States. In addition, there are more than a thousand suicides each year by younger children and teenagers who get access to firearms. Hundreds more die from accidental discharge. It is likely that many more children sustain serious wounds, or inflict such wounds accidentally on others. In order to limit the chance of such misuse, it is imperative that you keep this weapon locked in a secure place and take other steps necessary to limit the possibility of theft or accident. Failure to take reasonable preventative steps may result in innocent lives being lost, and in some circumstances may result in your liability for these deaths."

"IT IS UNLAWFUL TO STORE OR KEEP A FIREARM, RIFLE, SHOTGUN OR MACHINE GUN IN ANY PLACE UNLESS THAT WEAPON IS EQUIPPED WITH A TAMPER RESISTANT SAFETY DEVICE OR IS STORED OR KEPT IN A SECURELY LOCKED CONTAINER."

NEW JERSEY:

"IT IS A CRIMINAL OFFENSE TO LEAVE A LOADED FIREARM WITHIN EASY ACCESS OF A MINOR."

NEW YORK CITY, NY:

"THE USE OF A LOCKING DEVICE OR SAFETY LOCK IS ONLY ONE ASPECT OF RESPONSIBLE FIREARMS STORAGE. FOR INCREASED SAFETY, FIREARMS SHOULD BE STORED UNLOADED AND LOCKED IN A LOCATION THAT IS BOTH SEPARATE FROM THEIR AMMUNITION AND INACCESSIBLE TO CHILDREN AND OTHER UNAUTHORIZED PERSONS."

NORTH CAROLINA:

Any person who resides in the same premises as a minor, owns or possesses a firearm, and stores or leaves the firearm (i) in a condition that the firearm can be discharged and (ii) in a manner that the person knew or should have known that an unsupervised minor would be able to gain access to the firearm, is guilty of a Class 1 misdemeanor if a minor gains access to the firearm without the lawful permission of the minor's parents or a person having charge of the minor and the minor:

- (1) Possesses it in violation of G.S. 14-269.2(b)
- (2) Exhibits it in a public place in a careless, angry, or threatening Manner;
- (3) Causes personal injury or death with it not in self defense; or
- (4) Uses it in the commission of a crime.

TEXAS:

"IT IS UNLAWFUL TO STORE, TRANSPORT, OR ABANDON AN UNSECURED FIREARM IN A PLACE WHERE CHILDREN ARE LIKELY TO BE AND CAN OBTAIN ACCESS TO THE FIREARM."

WISCONSIN:

"IF YOU LEAVE A LOADED FIREARM WITHIN THE REACH OR EASY ACCESS OF A CHILD YOU MAY BE FINED OR IMPRISONED OR BOTH IF THE CHILD IMPROPERLY DISCHARGES, POSSESSES, OR EXHIBITS THE FIREARM."

Please check with your licensed retailer, state police, or local police for additional warnings, which may be required by local law or regulation. Such regulations change constantly, and local authorities are in the best position to advise you on such legal matters.

THE BASIC RULES OF SAFE FIREARMS HANDLING

1. ALWAYS treat every gun as if it were loaded.
2. ALWAYS be sure the barrel is clear of any obstruction.
3. ALWAYS be sure of your backstop, what lies beyond, and the safety of bystanders before you shoot.
4. ALWAYS use clean, dry, original factory-made ammunition of the proper type and caliber for your gun.
5. ALWAYS wear ear protection and safety glasses when shooting.
6. ALWAYS carry your gun so that you can control the direction of the muzzle if you fall or stumble.
7. NEVER shoot at a flat surface or water.
8. DO NOT leave an unattended gun loaded. Guns and ammunition should be stored separately, locked if possible, beyond the reach of children, careless adults, and unauthorized users.
9. NEVER allow your firearm to be used by anyone who has not read and understood this operator's manual.
10. DO NOT point any gun, loaded or unloaded, at any undesired target.
11. NEVER fire your rifle near an animal unless it is trained to accept the noise: an animal's startled reaction could injure it or cause an accident.
12. NEVER drink alcoholic beverages or take drugs before or during shooting, as your vision and judgment could be seriously impaired, making your gun handling unsafe.

⚠ WARNING – LOCKING DEVICES



This firearm was originally sold with a key-operated locking device. While it can help provide secure storage for your unloaded firearm, any locking device can fail. All guns are designed to fire if they are loaded and the trigger is pulled. Therefore, never install the locking device inside the trigger guard or in any way that makes it possible to pull the trigger! Do not leave the keys in the lock.

The ultimate responsibility for secure storage of any firearm must depend upon its owner and his or her individual circumstances. Firearms should be stored unloaded, in a secure location, separate from their ammunition.



**NEVER INSTALL THE
LOCKING DEVICE INSIDE
THE TRIGGER GUARD**

To maximize effectiveness and reduce the chances of malfunction or damage to a firearm, ALWAYS refer to the locking device's manufacturer directions for installation and removal of the device.

FIREARMS SAFETY IS YOUR RESPONSIBILITY

This owner's manual is designed to assist you in learning how to use and care for your SIG SAUER® pistol properly.

Only when you are certain that you fully understand this manual and can properly carry out its instructions, should you practice loading and firing your firearm with live ammunition. Having a gun in your possession is a full-time job; you cannot guess and you cannot forget. You must know how to use your firearm safely.

If you have any doubts about your ability to handle or use this firearm safely, you should seek supervised instruction. The Sig Sauer Academy™ provides all levels of firearms safety and skill training, from beginner to expert.

For more information contact:



www.sigsaueracademy.com • (603) 610-3400
Epping, New Hampshire

SAFETY MUST BE THE FIRST AND CONSTANT CONSIDERATION OF EVERY PERSON WHO HANDLES FIREARMS AND AMMUNITION.

For more information about safety, responsible firearms ownership, and shooting sports, contact:

National Rifle Association (NRA) of America
11250 Waples Mill Road, Fairfax, VA 22030-7400 • 1-800-672-3888
www.nra.com

TABLE OF CONTENTS

Topic	Page
State-By-State Warnings	2
The Basic Rules of Safe Firearms Handling	5
Locking Devices	6
Warnings of Great Importance	10
1.0 Safety Rules	11
1.1 Protect Your Eyes and Ears	11
2.0 Mechanical Characteristics and Weapon Theory	12
2.1 Weapon Description	12
2.1.1 General	12
2.1.2 Principal Features	12
2.1.3 Decocking Lever	14
2.2 Main Parts	15
3.0 Ammunition	16
4.0 Handling	20
4.1 Preparation Instructions	20
4.2 Loading the Magazine	20
4.3 Loading the Pistol (Ready to Fire)	21
4.4 Reloading During Shooting	22
5.0 Firing	24
5.1 Clearing a Jam	25
5.2 Firing the Pistol	26
6.0 Unloading the Pistol	28
6.1 Unloading the Pistol (Magazine Not Empty)	28
6.2 Unloading the Pistol (Magazine Empty, Slide Open)	29
7.0 Procedures in Case of Malfunction	31
7.1 Troubleshooting Guide	32
7.2 Minimize Malfunctions	33
8.0 Maintenance	34
8.1 Pistol Disassembly	35
8.2 Magazine Disassembly	37
8.3 Cleaning the Pistol	38
8.4 Pistol Assembly	39
8.5 Magazine Assembly	41
8.6 Function Verification	42

Topic	Page
9.0 Sights	47
9.1 General Information	47
9.2 Elevation Adjustment	48
10.0 Transportation and Storage	49
11.0 Service and Parts Policy	50
11.1 Parts Policy	50
11.2 Service Policy	51
11.3 Shipping Firearms for Repair	51
11.4 Ordering Parts	53
12.0 P220 DA/SA/DAK Parts Diagram	54
12.1 P220 SAO Parts Diagram	55
12.2 P220 Technical Specifications	56
12.3 P224 DAK/DA/SA Parts Diagram	58
12.4 P224 DAK/DA/SA Technical Specifications	59
12.5 P225 Parts Diagram	60
12.6 P225 Technical Specifications	61
12.7 P226 Parts Diagram	62
12.8 P226 Technical Specifications	63
12.9 P227 Parts Diagram	64
12.10 P227 Technical Specifications	65
12.11 P229 Parts Diagram	66
12.12 P229 Technical Specifications	67
12.13 P229 Carry Parts Diagram	68
12.14 P229 Carry Technical Specifications	69
12.15 P239 Parts Diagram	70
12.16 P239 Technical Specifications	71
Appendix A: Trigger Systems	72
Appendix B: P220 SAO Supplemental Instructions	73
Appendix C: SRT Supplemental Instructions	75
Warranty Information	76

WARNINGS OF GREAT IMPORTANCE ARE FOUND WITHIN THIS MANUAL

Locking Devices	6	Unloading	27, 30
Alterations	10	Jam	31, 33
Safety	11, 73, 74	Maintenance	34, 42
Ammunition	16	Disassembly	35, 36, 37
Lodged Bullet	18	Cleaning	38
Ammunition	19	Assembly	39, 41
Lead Exposure	19	Inspection	45
Loaded Pistol	23	Alterations	46
Trigger	24	Sight Adjustment	47, 48
Malfunction	24	Storage	49
Handling	25	Parts Purchasers	50
Dropped Pistol	25	Shipping	53

OTHER CAUTIONS AND WARNINGS APPEAR THROUGHOUT THE MANUAL

FIREARMS ARE DANGEROUS WEAPONS

**READ THE INSTRUCTIONS AND WARNINGS IN
THIS MANUAL THOROUGHLY AND CAREFULLY
BEFORE USING.**

⚠ WARNING – ALTERATIONS



This product was designed to function properly in its original condition. Alterations can make it unsafe. Do not alter any part or add or substitute any parts or accessories not manufactured by SIG SAUER Inc.

DO NOT ALTER ANY FIREARM

1.0 Safety Rules

The safety warnings in this manual are important. By understanding the dangers inherent in the use of any firearm, and by taking the precautions described herein, you can experience complete safety in the use of your pistol. Failure to heed any of these warnings may result in serious injury to you or others, as well as severe damage to the firearm or other property.

PISTOLS are classified as FIREARMS and are sold by SIG SAUER with the specific understanding that we shall not be responsible in any manner whatsoever for malfunctioning of the firearm, physical injury or property damage resulting in whole or in part from:

- criminal or negligent discharge;
- improper or careless handling;
- unauthorized modifications; defective, improper, hand-loaded, or
- or reloaded ammunition;
- corrosion;
- neglect; or
- other influences beyond our direct and immediate control.

This limitation applies regardless of whether liability is asserted on the basis of contract, negligence, or strict liability (including any failure to warn). Under no circumstance shall SIG SAUER, Inc. be liable for incidental or consequential damages, such as loss of use of property, commercial loss, and loss of earnings or profits.

1.1 Protect Your Eyes and Ears

Always wear safety glasses that meet the requirements of American National Standards Institute (ANSI) Z87.1 and ear plugs or " earmuff " type protectors whenever you are shooting. Always make certain that persons close to you are similarly protected. Unprotected eyes may be injured by powder, gas, carbon residue, lubricant, metallic particles, or similar debris that may emanate occasionally from any firearm in normal use. Without ear protection, repeated exposure to shooting noise may lead to cumulative, permanent hearing loss.

2.0 Mechanical Characteristics and Weapon Theory

2.1 Weapon Description

2.1.1. General

The SIG SAUER pistol is a modern handgun incorporating the latest technical advances in weapon design for military, law enforcement and sporting use. They are mechanically locked, short recoil operated pistols with semi-automatic reloading. Firing takes place with each pull of the trigger until the magazine is empty. The slide remains open after the last round has been fired from the magazine.

2.1.2 Principal Features

The automatic firing pin lock ensures safe carrying of the weapon and provides instant readiness without actuating a manual safety.

The double action feature and the absence of manual safeties make it easier for you to get off a quick first shot.

A decocking lever* allows you to lower the cocked hammer safely into the safety intercept notch without your touching the trigger.

Distinctive high contrast sights, in conjunction with the ergonomically correct grip, ensure rapid target acquisition and engagement, even under poor lighting conditions.

An accessory rail is integrated into the frame on certain models, facilitating the easy attachment of industry standard tactical accessories.

The closed design of the pistol helps keep dirt and other debris from entering the pistol, ensuring proper function in harsh environmental conditions.

*Does not apply to double action only (DAO) pistols. See Below.

IMPORTANT

Read this if you own a SIG SAUER Double Action Only (DAO) Pistol

The DAO/DAK differs from the standard pistol in several ways:

FIRST, there's no single action position for the hammer. It returns to a decocked position after each trigger pull, so it can be fired only in double action mode.

SECOND, because it's double action only, there's only one trigger pull to learn.

THIRD, because the hammer returns to a decocked position after each shot, there's no need for a decocking lever.

In all other respects, the DAO/DAK is identical in design and function. In this manual, whenever there's an instruction or information that doesn't apply to the DAO/DAK, we'll note it.

Note: For a description of various trigger systems, see Appendix A.

2.1.3 What You Should Know About the Decocking Lever

The decocking lever on the SIG SAUER pistol is designed for the express purpose of decocking the firearm. The reason it is there is because it is not safe practice to decock a pistol by pulling the trigger and attempting to ease the hammer forward manually.

To decock your pistol, push down the decocking lever (keep your finger OFF the trigger while you do this).



WARNING

– DECOCKING LEVER

Always use the decocking lever to decock your SIG SAUER pistol. This is the only way to safely lower the hammer from the cocked position and prevent an accidental discharge. This warning applies to all pistols with decocking levers.

The positive way to safely lower the hammer is by use of the decocking lever. Never lower the hammer by pulling the trigger and attempting to ease the hammer forward manually. Manually lowering the hammer is dangerous and prevents full application of the pistol's safety features.

The decocking lever is the only proper means of lowering the hammer and assuring that the hammer rests in the intercept notch.

Again, DO NOT THUMB THE HAMMER DOWN:

the consequence can be serious injury or death – only and ALWAYS use the decocking lever!

2.2 Main Parts



- | | |
|---------------------|-------------------------|
| 1 Frame | 21 Barrel |
| 2 Magazine Catch | 24 Slide |
| 5 Takedown Lever | 25 Front Sight |
| 8 Slide Catch Lever | 26 Rear Sight |
| 13 Trigger | 38 Magazine Floor Plate |
| 14 Hammer | 40 Decocking Lever |

3.0 Ammunition

1. Use only high-quality, original, factory-manufactured ammunition. Do not use cartridges that are dirty, wet, corroded, bent, or damaged. Do not oil cartridges. Do not spray aerosol-type lubricants, preservatives, or cleaners directly onto cartridges or where excess spray may flow into contact with cartridges. Lubricant or other foreign matter on cartridges can cause potentially dangerous ammunition malfunctions. Only use ammunition of the caliber for which your firearm is chambered. The proper caliber is permanently engraved on your firearm; never attempt to use ammunition of any other caliber.

2. The use of reloaded, “remanufactured” hand-loaded, or other non-standard ammunition voids all warranties. Reloading is a science and improperly loaded ammunition can be extremely dangerous. Severe damage to the firearm and serious injury to the shooter or to others may result. Always use ammunition that complies with the industry performance standards established by the Sporting Arms and Ammunition Manufacturers’ Institute, Inc. (SAAMI) of the United States or ammunition manufactured to military specifications.

WARNING – AMMUNITION (CARTRIDGE) NOTICE

SIG SAUER SPECIFICALLY DISCLAIMS RESPONSIBILITY FOR ANY DAMAGE OR INJURY WHATSOEVER OCCURRING IN CONNECTION WITH, OR AS A RESULT OF, THE USE IN ANY SIG SAUER FIREARM OF FAULTY, NON-STANDARD, “REMANUFACTURED” HAND-LOADED (RELOADED) AMMUNITION, OR CARTRIDGES OTHER THAN THOSE FOR WHICH THE FIREARM WAS ORIGINALLY CHAMBERED.

3. Firearms may be severely damaged and serious injury to the shooter or to others may result from any condition causing excessive pressure inside the chamber or barrel during firing. Excessive pressure can be caused by obstructions in the barrel, propellant powder overloads, the use of incorrect cartridges, or defectively assembled cartridges. In addition, the use of a dirty, corroded, or damaged cartridge can lead to a burst cartridge case and consequent damage to the firearm and personal injury from the sudden escape of high-pressure propellant gas within the firearm's mechanism.

4. Immediately stop shooting and check the barrel for a possible obstruction whenever:

- You have difficulty in, or feel unusual resistance in, chambering a cartridge
- A cartridge misfires (does not go off)
- The mechanism fails to extract a fired cartridge case
- Unburned grains of propellant powder are discovered spilled in the mechanism
- A shot sounds weak or abnormal. In such cases it is possible that a bullet is lodged partway down the barrel. Firing a subsequent bullet into the obstructed barrel can wreck the firearm and cause serious injury to the shooter or to bystanders

5. Bullets can become lodged in the barrel:

- If the cartridge has been improperly loaded without propellant powder, or if the powder fails to ignite (ignition of the cartridge primer alone will push the bullet out of the cartridge case, but usually does not generate sufficient energy to expel the bullet completely from the barrel).
- If the bullet is not properly seated in the cartridge case. When such a cartridge is extracted from the chamber without being fired, the bullet may be left behind in the bore at the point where the rifling begins. Subsequent chambering of another cartridge may push the first bullet further into the bore.

6. If there is any reason to suspect that a bullet is obstructing the barrel, immediately unload the firearm and look through the bore. It is not sufficient to merely look in the chamber. A bullet may be lodged some distance down the barrel where it cannot easily be seen.

 WARNING – LODGED BULLET

IF A BULLET IS IN THE BORE, DO NOT ATTEMPT TO SHOOT IT OUT BY USING ANOTHER CARTRIDGE OR BY BLOWING IT OUT WITH A BLANK OR ONE FROM WHICH THE BULLET HAS BEEN REMOVED. SUCH TECHNIQUES CAN GENERATE EXCESSIVE PRESSURE, DAMAGE THE FIREARM, AND CAUSE SERIOUS PERSONAL INJURY.

If the bullet can be removed with a cleaning rod, clean any unburned powder grains from the bore, chamber, and mechanism before resuming shooting. If the bullet cannot be dislodged by tapping it with a cleaning rod, send the firearm to SIG SAUER.

7. Dirt, corrosion, or other foreign matter on a cartridge can impede complete chambering and may cause the cartridge case to burst upon firing. The same is true of cartridges that are damaged or deformed.

8. Do not oil cartridges, and be sure to wipe the chamber clean of any oil or preservative before commencing to shoot. Oil interferes with the friction between cartridge case and chamber wall that is necessary for safe functioning, and subjects the firearm to stress similar to that imposed by excessive pressure.

9. Use lubricants sparingly on the moving parts of your firearm. Avoid excessive spraying of any aerosol gun care product, especially where it may get on ammunition. All lubricants and aerosol spray lubricants, in particular, can penetrate cartridge primers and cause misfires. Some highly penetrative lubricants can also migrate inside cartridge cases and cause deterioration of the propellant powder; on firing, the powder may not ignite. If only the primer ignites, there is danger that the bullet may become lodged in the barrel.

⚠ WARNING – AMMUNITION

Death, serious injury, and damage can result from the use of wrong ammunition, bore obstructions, powder overloads, or incorrect cartridge components. Always wear shooting glasses and hearing protectors.

IMPROPER AMMUNITION DESTROYS FIREARMS**⚠ WARNING – LEAD EXPOSURE**

Discharging firearms in poorly ventilated areas, cleaning firearms, or handling ammunition may result in exposure to lead and other substances known to the state of California to cause birth defects, reproductive harm, and other serious physical injury. Maintain adequate ventilation at all times. Wash hands thoroughly after exposure.

SHOOTING OR CLEANING FIREARMS MAY EXPOSE YOU TO LEAD

4.0 Handling

4.1 Preparation Instructions

Prior to firing the pistol for the first time, we strongly suggest you perform an initial cleaning and lubrication of the pistol once it is unpacked. Any fouling present will have been from final range firing at the factory prior to shipping. Please refer to Section 8.0 for instructions pertaining to cleaning the pistol. If you have the pistol and ammunition, and have read and understood all of the safety instructions, you are now ready to use the pistol.

4.2 Loading the Magazine

1. Ensure the magazine is the proper type and caliber for the pistol.
2. Press down on the magazine follower with the cartridge case rim. Ensure the bullet is facing the front of the magazine.
3. Push the cartridge to the rear and under the magazine lips.
4. Repeat until the magazine holds the desired number of cartridges.

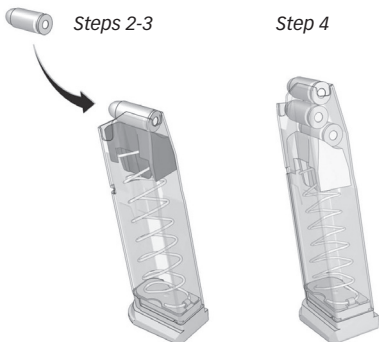

4.3 Loading the pistol (ready to fire)

1. Point the pistol in a safe direction.
2. Insert a full magazine and ensure it is engaged.
3. Pull the slide back fully and release, allowing the slide to return forward.
4. Push down the decocking lever with your thumb (Not valid for DAO/DAK pistols).

⚠ WARNING – LOADED PISTOL

THE PISTOL IS NOW LOADED AND READY TO FIRE.

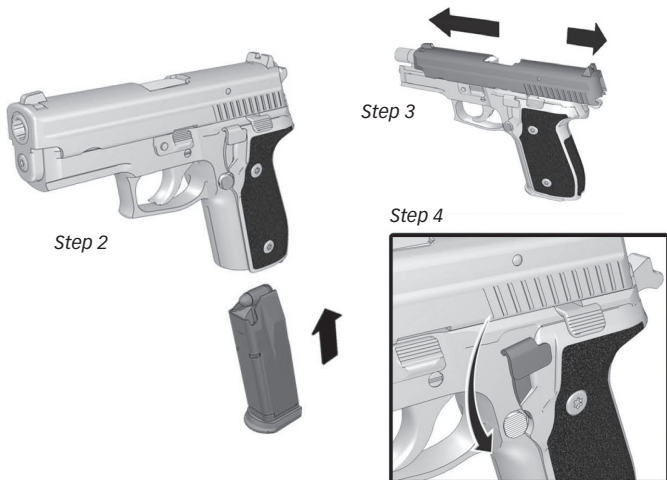

4.4 Reloading During Shooting

When the last round in the magazine is expended, the slide will be locked back in the open position by the slide catch lever.

1. Depress the magazine catch.
2. Remove the empty magazine.

Step 1



Step 2

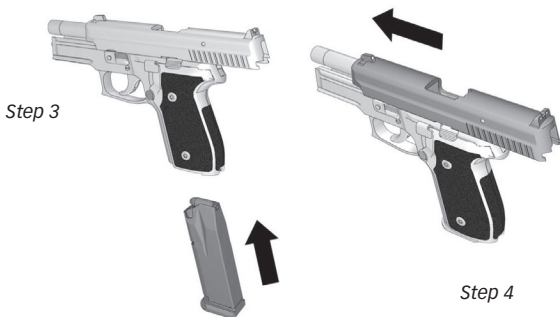

3. Insert a loaded magazine, making sure it is engaged.
4. Release the slide by:
 - a. Pressing down on the slide catch lever or,
 - b. Pulling back on the slide and release

**⚠ WARNING – LOADED PISTOL****The pistol is now loaded and ready to fire.**

Always make sure the muzzle is pointed in a safe direction! Never attempt to load or unload any firearm inside a vehicle, building, or other confined space (except a properly constructed shooting range). Enclosed areas frequently offer no completely safe direction to point the firearm; if an accidental discharge occurs, there is great risk of bodily injury or property damage. Before loading, always clean all grease and oil from the bore and chamber, and check to be certain that no obstruction is in the barrel. Any foreign matter in the barrel could result in a bulged or burst barrel or other damage to the firearm, and could cause serious injury to the shooter or to others.

5.0 Firing

WARNING – TRIGGER

DO NOT TOUCH THE TRIGGER UNTIL YOU ARE ACTUALLY READY TO FIRE THE PISTOL.

Keep the muzzle pointed in a safe direction and your finger away from the trigger when cocking any firearm.

Never fire any firearm with your finger, hand, face, or other part of your body over or adjacent to the ejection port, or in any position where you may be struck by reciprocating movement of the breech. Both the ejection of empty cartridge cases and the movement of the breech are part of the normal operating cycle of firearms, and pose no safety hazard to the shooter if the firearm is held in a normal grip and fired at arm's length.

Never allow other persons to stand beside you where they might be struck by an ejected cartridge case. The case is hot, and may be ejected with sufficient force to cause a burn, cut, or other injury. Wear safety glasses to protect eyes. Make certain there is a clear, unobstructed path for safe ejection of the fired case. Remember, the case may bounce off a hard object nearby and strike you or someone else.

WARNING – MALFUNCTION

If, while shooting, your firearm develops a mechanical malfunction or binding, or “spits” powder/gas, or if a cartridge primer is punctured, or a cartridge case is bulged or ruptured, or if the report on firing does not sound quite right, STOP SHOOTING IMMEDIATELY! It may be dangerous to continue. UNLOAD THE FIREARM – DO NOT try “one more shot.” Take the firearm and the ammunition to a gunsmith for examination.

5.1 Clearing a Jam

While shooting any firearm, an unfired cartridge or fired cartridge case may occasionally become jammed between the slide and the barrel. WHILE KEEPING THE MUZZLE POINTED IN A SAFE DIRECTION, clear the jam as follows:

1. Remove the magazine.
2. Pull back the slide and lock it to the rear by pushing up the slide catch lever.
3. The jammed cartridge or case now can be removed by shaking it out or by picking it out.

⚠ WARNING – HANDLING



The slide opens and shuts quickly while firing. Keep face and hands away from it. Hot brass and powder gas is ejected quickly and can burn you. Always wear safety glasses and hearing protectors.

SLIDE OPENS FAST – HOT BRASS EJECTED

⚠ WARNING – DROPPED PISTOL



If dropped, the pistol may fire. Keep the chamber empty unless actually firing!

ANY FIREARM MAY FIRE IF DROPPED

5.2 Firing the Pistol

1. Aim the pistol at a safe target
2. Place finger on the trigger and press rearward to discharge.



Step 2

3. Keep pistol aimed at the target and continue to fire as required or until the pistol is empty.
5. Remove the magazine, unload and clear the pistol (see section 6.0 "Unloading the Pistol"). If the pistol is fired until the magazine is empty, the slide will remain locked to the rear. If firing is to continue, reload the pistol (see section 4.4 "Reloading During Shooting").

⚠ WARNING – UNLOADING

Removing cartridges from the magazine does not prevent the pistol from being fired! When there is a cartridge in the chamber, the cartridge will discharge if the trigger is pulled. It is absolutely essential for the user to know how to completely unload the pistol. "Completely" means emptying the magazine and removing a chambered cartridge.

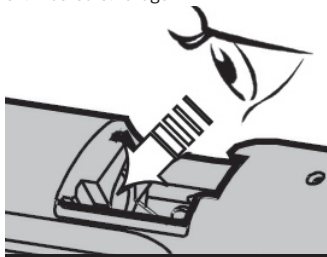

**PISTOL WILL FIRE WITH MAGAZINE EMPTY
OR REMOVED**

6.0 Unloading the Pistol

6.1 Unloading the Pistol (Magazine not Empty)

1. Keep the muzzle pointed in a safe direction.
2. Depress the magazine catch and remove the magazine.
3. Pull the slide back to the stop and engage the slide catch lever. The round is ejected and the slide is locked open.
4. Visually and manually check the chamber to ensure the pistol is completely free of ammunition.
5. Depress the slide catch lever, causing the slide to close.
6. Remove all ammunition from magazine.

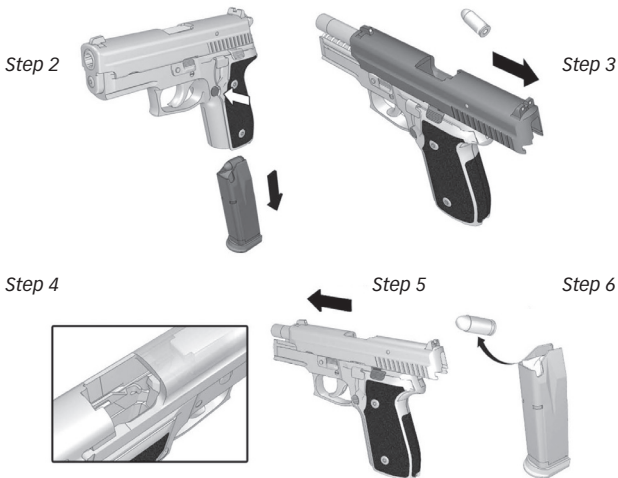

6.2 Unloading the Pistol (Magazine Empty, Slide Locked to the Rear)

1. Keep the muzzle pointed in a safe direction.
2. Depress the magazine catch and remove the magazine.
3. Visually and manually check the chamber to ensure the pistol is completely free of ammunition.
4. Depress the slide catch lever, causing the slide to close.

Step 2



Step 3

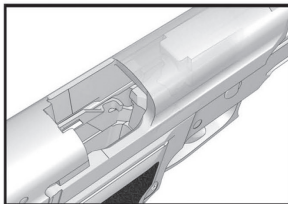

Step 4



Always make sure the muzzle is pointed in a safe direction! Remember to clear the chamber after the magazine has been removed.

Never assume that any gun is unloaded until you have personally checked it, visually and physically!

After every shooting practice, make a final check to be certain the firearm is unloaded before leaving the range.

⚠ WARNING – UNLOADING



Removing cartridges from the magazine does not prevent the pistol from being fired! When there is a cartridge in the chamber, the cartridge will discharge if the trigger is pulled. It is absolutely essential for the user to know how to completely unload the pistol. "Completely" means emptying the magazine and removing a chambered cartridge.

**PISTOL WILL FIRE
WITH MAGAZINE
EMPTY OR REMOVED**

7.0 Procedures in Case of Malfunction (“Jam”)

Follow the malfunction mitigation procedures if:

- You notice that a cartridge is difficult to chamber
- A cartridge does not go off
- The mechanism fails to extract a fired cartridge case
- You discover unburned grains of propellant powder spilled in the mechanism
- A shot sounds or feels weak or abnormal

⚠ WARNING – JAM

LIVE ROUND JAM MAY NOT EJECT.

Firearms work reliably if properly maintained. If there is a malfunction during firing:

1. Keep the pistol pointed in a safe direction with your finger off the trigger.
2. Remove and secure the magazine.
3. Move the slide rearward and forward to clear any cartridge case in or near the chamber. Visually and manually inspect the chamber.
4. If you suspect that a bullet is lodged in the bore, field strip your pistol and check to see if the barrel is blocked. If there is a bullet lodged in the bore, return the pistol to SIG SAUER (see section 11.3 “Shipping Firearms for Repair”).

⚠ WARNING – JAM

IF A BULLET IS IN THE BORE, DO NOT ATTEMPT TO SHOOT IT OUT BY USING ANOTHER CARTRIDGE, OR BY BLOWING IT OUT WITH A BLANK OR A CARTRIDGE FROM WHICH THE BULLET HAS BEEN REMOVED. THIS CAN GENERATE EXCESSIVE PRESSURE, DAMAGE THE FIREARM AND CAUSE SERIOUS PERSONAL INJURY OR DEATH.

7.1 Troubleshooting Guide

Malfunction	Cause	Correction
Feed		
No round fed into the chamber	Magazine not properly inserted or magazine is deformed or dirty	Insert magazine properly or change magazine
Slide does not close easily or completely	Pistol or cartridge is fouled (dirty) or pistol is too heavily lubricated	Clean and lubricate pistol and/or replace the ammunition
	Incorrect ammunition	Replace ammunition
	Pistol requires service	Return to SIG SAUER
Extraction/Ejection		
After firing, the case stays in the chamber or is jammed in the ejection port	Insufficient recoil due to dirt	Clean and lubricate the pistol
	Light hold or limp wrist	Solid grip, rigid hold
	Low-powered ammunition	Change ammunition
	Pistol requires service	Return to SIG SAUER
Ignition		
Hammer drops but round does not fire	Firing pin obstructed	Inspect, clean and lubricate the pistol
	Faulty ammunition	Manually cycle in next round
	Pistol requires service	Return to SIG SAUER

⚠ WARNING – JAMS

If your pistol stops firing with a live round in the chamber of a hot barrel (a misfire or jam), remove the round immediately. If you cannot remove the round within 10 seconds, remove the magazine and wait at least 15 minutes with the pistol pointing in a safe direction. This way, neither the user nor any other person would be injured by the possibility of a round “cooking-off” (a round detonating due to the heat of the barrel). Keep your face away from the ejection port while clearing a hot chamber.

7.2 Minimizing Malfunctions (“Jams”)

Malfunctions can largely be avoided by cleaning the pistol (see section 8.3 “Cleaning the Pistol”).

- After each firing session
- Whenever a buildup of firing residue is suspected
- Whenever the pistol is exposed to extreme environmental conditions (rain, snow, freezing temperatures, etc.)

8.0 Maintenance

⚠ WARNING – MAINTENANCE

Verify the magazine is removed – visually and physically confirm the pistol is unloaded before attempting disassembly or performing any maintenance steps. Failure to ensure the firearm is unloaded could result in unintentional discharge, causing injury or death.



VERIFY THE FIREARM IS UNLOADED

8.1 Pistol Disassembly

1. Unload the pistol (see section 6.0 “Unloading the Pistol”).
2. Retract the slide to the stop and lock open by engaging the slide catch lever.
3. Verify visually and physically that there is no round in the chamber.
4. Rotate the takedown lever clockwise to a vertical (6 o'clock) position.

Note: Steps 5 and 6 below are not applicable to SRT (Short Reset Trigger) models. See Appendix C.

5. Retract the slide slightly to disengage the slide catch lever. Allow the slide to move forward in a controlled fashion.

⚠ WARNING – DISASSEMBLY

Slide is under spring tension. Maintain positive control during slide removal to prevent damage or injury. Wear eye protection.

6. Move the complete slide assembly (slide, barrel, recoil spring and guide) forward and off the frame.

Step 2



Step 4



Step 5



Step 6



⚠ WARNING – DISASSEMBLY

The recoil spring and guide are under spring tension and not firmly attached to the slide. Use caution to prevent injury or damage to the pistol. Wear eye protection.

7. Push the recoil spring guide forward slightly and lift from rear to remove the recoil spring and guide from the slide.
8. Remove the barrel from the slide by pulling upward slightly and to the rear. This level of disassembly is sufficient to allow a thorough cleaning after shooting.

Step 7

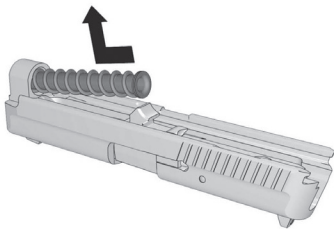

Step 8

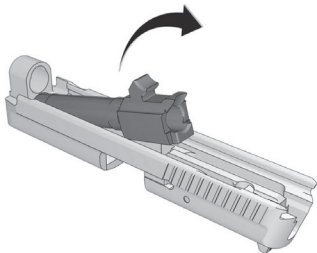

8.2 Magazine Disassembly

1. Locate the bottom of the magazine floorplate.
2. Using a punch, cleaning rod, or similar tool, depress the magazine insert and push the magazine floorplate forward until it is clear of the magazine tube.

⚠ WARNING – DISASSEMBLY

The magazine spring is compressed. Guard the magazine insert and magazine spring with your thumb to control the release of magazine spring tension. Uncontrolled release can cause injury. Wear eye protection.

3. Remove the magazine follower and magazine spring from the magazine tube. This level of disassembly is sufficient to allow a thorough cleaning after shooting.

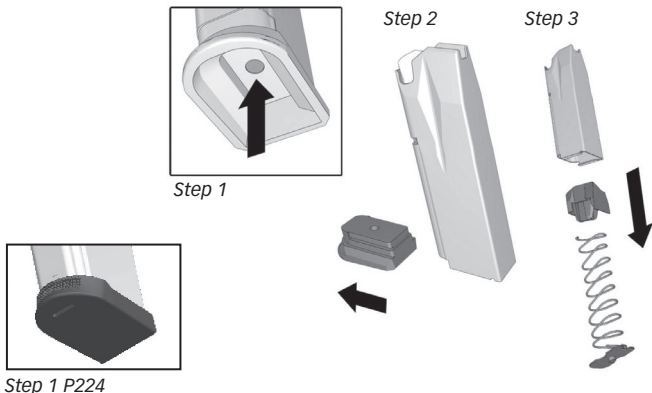

Step 1 P224

8.3 Cleaning the Pistol

⚠ WARNING – CLEANING

Never clean the barrel from the muzzle end; do not use a steel wire brush as it can damage the smooth surface of the barrel. Use a suitable cleaning rod and a brush of the correct caliber.

Solvents can be harmful to the surface finish of the pistol. Read and follow the manufacturer's warnings before using solvents or cleaners. Wear eye protection.

Avoid over-lubrication of components.

1. Lubricate the cleaning brush with gun oil and insert it into the barrel via the chamber (opposite the muzzle end).
2. Wipe powder residues and oil from the barrel bore and chamber with cleaning patches.
3. Clean exterior surfaces of the barrel with a brush coated with gun oil.
4. Remove dirt from guides of the frame, inside and outside of slide, recoil spring guide and recoil spring with a brush or cleaning patch. Lightly lubricate same surfaces with a cloth impregnated with gun oil or gun grease.
5. Lightly oil bores of the barrel and chamber. Remove any excess lubricant.

Note: TW-25B or a like lubricant designed for stainless steel is recommended for "All Stainless" models, such as the P220 ST or P226 ST.

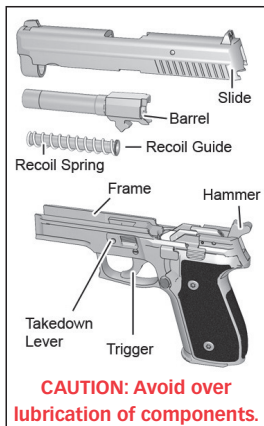

8.4 Pistol Assembly

1. Verify the pistol is clear of all foreign matter.
2. Insert the barrel into the slide.

⚠ WARNING – ASSEMBLY

The recoil spring and guide are under spring tension and not firmly attached to the slide. Use caution to prevent injury or damage to the pistol. Wear eye protection.

Step 2

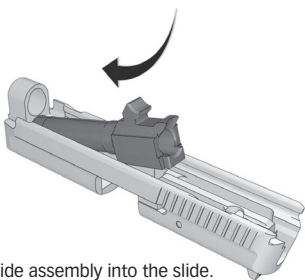

3. Insert recoil spring guide assembly into the slide.

Step 3

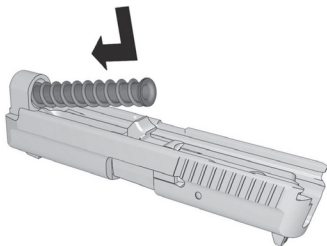

4. Ensure the takedown lever is rotated clockwise to the vertical position (6 o'clock).
5. Guide the slide onto the frame rails from the front.
6. Retract the slide fully to the rear. Engage the slide catch lever to lock the slide in the open position.
7. Rotate the takedown lever counter-clockwise until horizontal.
8. Depress the slide catch lever to release the slide.
9. Decock the hammer with the decocking lever (not applicable to DAO/DAK pistols).

Step 4

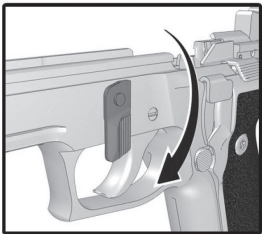

Steps 5, 6, & 7



Step 8



Step 9



8.5 Magazine Assembly

1. Correctly position the magazine follower on the magazine spring and insert into the bottom of the magazine tube.

⚠ WARNING – ASSEMBLY

The magazine spring is being compressed during assembly. Guard the magazine insert and magazine spring with your thumb to control magazine spring tension. Uncontrolled release can cause injury. Wear eye protection.

2. Insert the magazine spring fully into the magazine tube until the magazine insert is flush with the magazine tube bottom.

3. Holding the magazine insert in place, slide the magazine floorplate onto the magazine tube lips until the magazine floorplate is locked in place by the magazine insert.

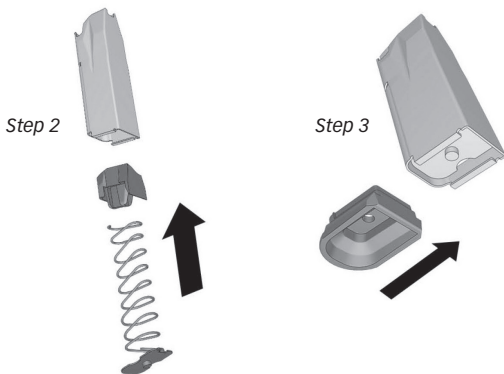

8.6 Function Verification

The function check is performed on the assembled pistol to verify functionality. It should be performed after the completion of repairs and after each cleaning and assembly of the pistol.

⚠ WARNING – MAINTENANCE

Verify the magazine is removed – visually and physically confirm the pistol is unloaded before attempting disassembly or performing any maintenance steps. Failure to ensure the firearm is unloaded could result in unintentional discharge, causing injury or death.



VERIFY THE FIREARM IS UNLOADED

1. Ensure the magazine is removed and the pistol is unloaded (see section 6.0 "Unloading the Pistol").
2. Check recoil spring function/slide travel.
 - a. Retract the slide fully and release.
 - b. Verify the slide locks fully in the closed position.
 - c. Repeat the procedure.
3. Check the trigger mechanism:
 - a. Pull the trigger fully to the rear.
 - b. As the trigger is pulled rearward, verify the hammer cocks. At the end of trigger travel, the hammer should fall forward firmly.

Step 2a

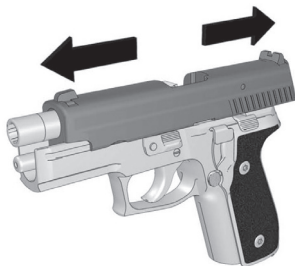

Step 3a - 3b



4. Check slide catch lever.
 - a. Insert an empty magazine.
 - b. Retract the slide fully and release.
 - c. Verify the slide is locked to the rear by the slide catch lever.
 - d. Depress the slide catch lever.
 - e. Verify the slide is released and closes in the locked position.
 - f. Remove the magazine.
5. Inspect the magazine.
 - a. Check the condition of the magazine tube.
 - b. Verify the magazine floorplate is secure.
 - c. Check for free movement of the magazine follower and spring.
 - d. Insert the magazine into the pistol and remove. Verify smooth insertion. Check the magazine catch for clean engagement and smooth release.

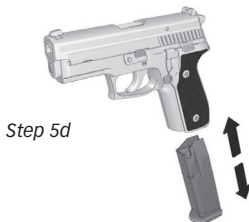
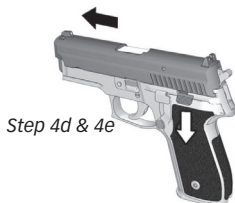
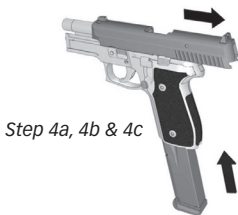

6. Inspect the pistol exterior.
 - a. Inspect the general condition of the pistol.
 - b. Check the sights, body, slide, and takedown lever for damage.
 - c. Verify the front and rear sights are secure.

⚠ WARNING – INSPECTION

Never use a firearm or magazine that shows signs of damage or fails a function check. Verify the magazine is the correct model and caliber for the pistol. If the condition or function of the pistol or magazine is suspect, return the pistol or magazine to SIG SAUER for evaluation.



VERIFY THE CONDITION AND FUNCTION

⚠ WARNING – ALTERATIONS

This product was designed to function properly in its original condition. Alterations can make it unsafe. Do not alter any part or add or substitute any parts or accessories not manufactured by SIG SAUER for this pistol.



DO NOT ALTER ANY FIREARM

9.0 Sights

9.1 General Information

The SIG SAUER pistol is equipped with drift adjustable fixed sights which have proven their worth under severe conditions. The sights consist of a rear sight and a front sight blade, designed and dimensioned to ensure rapid target acquisition even when visibility is poor.

⚠ WARNING – SIGHT ADJUSTMENT

Sight corrections should only be performed by someone with the necessary knowledge – the pistol could become damaged.

9.2 Windage (Left/Right) Adjustment

Change windage by moving the rear sight either to the left or right in its dovetail. When you do this, follow the rear sight rule: Move the rear sight in the direction you want the group to go. Moving the rear sight 0.020" in the dovetail changes the point of impact by approximately 3" at 25 yards.

Note: SIG SAUER has a Sight Adjustment Tool available that makes it easier to adjust and change sights.

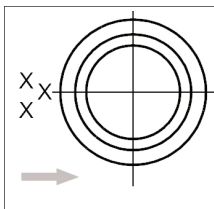

Impact left of point of aim

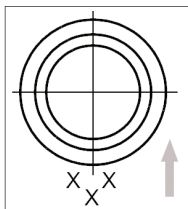

Impact low of point of aim

9.2 Elevation (Up/Down) Adjustment

There are different height combinations available for the front and rear sights. The sights are numbered according to their height. You can change elevation by changing either the rear or front sight. It's easier if you change the rear sight first.

There are six rear sight heights available. Each rear sight change will move the impact of the bullet approximately 2" at 25 yards.

There are five front sight heights available. Each front sight change will move the impact of the bullet approximately 1" at 25 yards.

When changing sights, remember this rule: NUMBERS UP, GROUPS UP; NUMBERS DOWN, GROUPS DOWN. This is true for both front & rear sights.

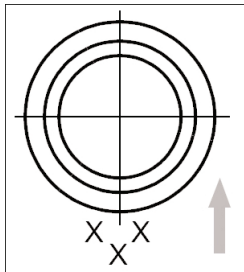

Impact low of point of aim

⚠ WARNING – SIGHT ADJUSTMENT



Sight corrections should **ONLY** be performed on an unloaded firearm. Manipulating the sights on a loaded firearm could result in unintentional discharge, causing injury or death. Visually and physically confirm the pistol is unloaded before making sight adjustments.

**DO NOT ADJUST THE SIGHTS
ON A LOADED FIREARM**

10.0 Transportation and Storage

When transporting your firearm to and from shooting activities, keep it unloaded for your safety and for the safety of others. When storing your firearm, keep it separated from ammunition, under lock and key if possible, and out of the reach of children and other inexperienced or unauthorized persons.

⚠ WARNING – STORAGE

Never place or store any firearm in such a manner that it may be dislodged. Firearms should always be stored securely and unloaded, away from children and other unauthorized users. Use the locking device originally supplied with this firearm for storage. The use of a locking device or safety lock is only one aspect of responsible firearms storage. For increased safety, firearms should be stored unloaded and locked in a location that is both separate from their ammunition and inaccessible to children and any other unauthorized person.



STORE SECURELY AND UNLOADED

11.0 Service and Parts Policy

11.1 Parts Policy

Our Service Department maintains a full complement of replacement parts. Even though most gunsmiths have the knowledge, training, and the ability to make necessary repairs to your firearm, the skill and workmanship of any particular gunsmith is totally beyond our control.

Should your firearm ever require service, we strongly recommend that you return it to SIG SAUER (see section 11.3 "Shipping Firearms for Repair"). A firearm is a precision instrument and some replacement parts will require individual fitting to ensure correct operation. A wrong part, improper fitting, or incorrect mechanical adjustment may result in an unsafe condition or dangerous malfunction, damage to the firearm, or cause possible serious injury to the shooter or others.

IF ANY PART IS ORDERED WITHOUT RETURNING THE FIREARM TO SIG SAUER, the customer bears full responsibility for ensuring that the part supplied is correct for their particular firearm and is properly installed and fitted by a qualified gunsmith.

SIG SAUER CANNOT BE RESPONSIBLE FOR THE FUNCTIONING OF ANY FIREARM IN WHICH REPLACEMENT PARTS ARE INSTALLED BY OTHERS.

▲ WARNING – PARTS PURCHASERS

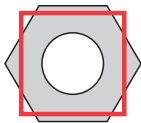

It is the purchaser's responsibility to be absolutely certain that any parts ordered from the factory are correctly fitted and installed. Firearms are complicated mechanisms and **IMPROPER FITTING OF PARTS MAY RESULT IN A DANGEROUS MALFUNCTION, DAMAGE TO THE FIREARM, AND SERIOUS INJURY TO THE SHOOTER AND OTHER PERSONS.** The purchaser and installer of parts must accept full responsibility for the correct adjustment and functioning of the firearm after such installation. **PARTS MUST FIT CORRECTLY**

11.2 Service Policy

If you have questions concerning the performance or servicing of your firearm, please write or call:

SIG SAUER, Inc.
Attention: Customer Service
18 Industrial Drive, Exeter, NH 03833
Phone: (603) 610-3000 ext. 1
Fax: (603) 766-7002

IF YOU DO NOT UNDERSTAND THE INSTRUCTIONS FOR OPERATING YOUR PISTOL, IT IS YOUR RESPONSIBILITY TO CALL OUR CUSTOMER SERVICE DEPARTMENT AT (603) 610-3000 EXT. 1 BEFORE USING YOUR FIREARM.

11.3 Shipping Firearms for Repair

In the event you need to return your firearm to the SIG SAUER Service Department, here's what to do:

1. First contact Customer Service at (603) 610-3000 ext. 1 for an RMA number, which will allow SIG SAUER to track the status of your return from its receipt at SIG SAUER through its return to you. Please do not send your firearm until you obtain an RMA number.
2. Make sure that the chamber and magazine(s) are unloaded and that no ammunition is included with your returned firearm.
3. Package the firearm securely to prevent damage. Enclose a letter that includes your name, street address, daytime phone number, model and serial number, and a detailed description of the problem you have experienced or the work you want performed. With the exception of extra magazines, do not include any other accessories such as scopes or mounts.

4. Generally, an individual may ship firearms to the manufacturer for repair or service. Some states and localities, however, prohibit this. If you live in such an area, the firearms must be shipped by and returned to a federally licensed firearms dealer.

5. Federal law prohibits persons who do not possess a Federal Firearms License from shipping a firearm via the U.S. Postal Service. (Note: any shipment of firearms outside U.S. borders is subject to the export laws of the United States and to the valid laws of the specific country, which you must strictly follow; prior to exporting any firearm you should seek legal counsel.)

6. SIG SAUER is not responsible for any firearm until it is received, nor for damage incurred during shipment.

7. Ship your firearms insured and prepaid (we do not accept collect shipments) to:

SIG SAUER, Inc.
Attention: Service Department
18 Industrial Drive Exeter, NH 03833

Don't forget to write your RMA number on the package.

A copy of this instruction manual should always accompany this pistol and be transferred with it upon change of ownership.

11.4 Ordering Parts

SIG SAUER offers a limited number of repair parts that can be purchased and installed by the end user without voiding the warranty of the firearm.

In the event you want to order parts for your firearm, contact Customer Service at (603) 610-3000 ext. 1.

Have available the serial number of your firearm and a description of the part(s) you wish to order. A diagram of the pistol is provided in section 12.0.

Please refer to the Service and Parts Policy.

⚠ WARNING – SHIPPING



Before shipping any firearm, be absolutely certain that the firearm and its magazines are unloaded.

DO NOT ship ammunition with a firearm. Failure to follow this warning could result in unintentional discharge, causing injury or death.

**VERIFY THE FIREARM IS
UNLOADED**

12.0 P220 SA/DA/DAK Parts Diagram

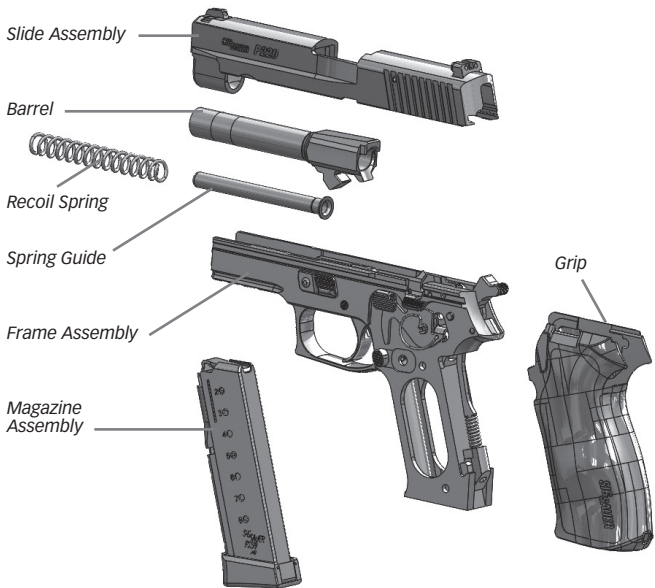

12.1 P220 SAO Parts Diagram

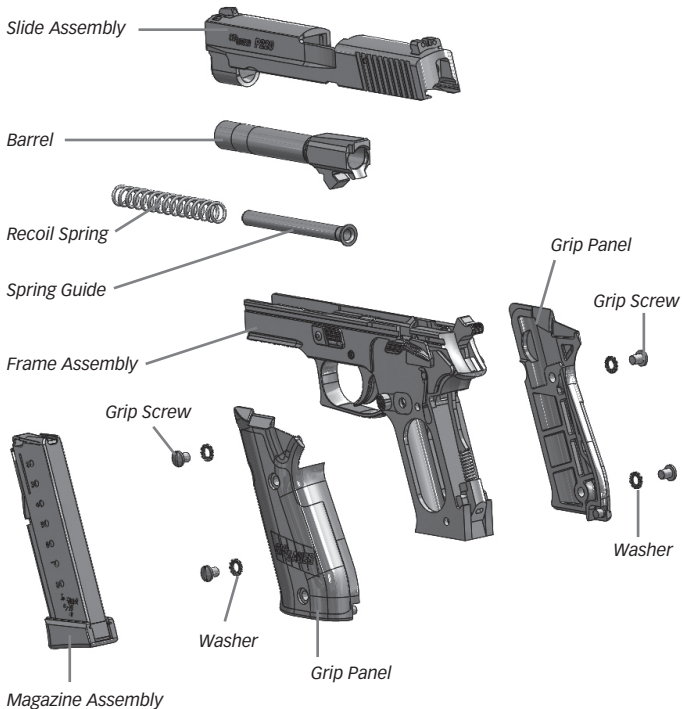

12.2 P220 Technical Specifications

P220 Type	Super Match	Match	Elite
Caliber	.45 ACP	.45 ACP	.45 ACP
Length, Overall	8.92"	8.30"	8.32"
Height, Overall	5.50"	5.50"	5.50"
Width, Overall	1.60"	1.50"	1.60"
Barrel Length	5.0"	5.0"	4.4"
Rifling Twist	1 in 16"	1 in 16"	1 in 16"
Sight Radius	6.82"	6.82"	6.30"
Weight (alloy) w/mag	33.6 oz	33.6 oz	30.4 oz
Weight (stainless) w/mag	N/A	N/A	39.1 oz
Trigger pull weight DA	10 lbs	10 lbs	10 lbs
Trigger pull weight SA	4.4 lbs	4.4 lbs	4.4 lbs
Trigger pull weight DAK	7.5 lbs	7.5 lbs	7.5 lbs
Trigger pull weight SAO	5 lbs	5 lbs	5 lbs
Magazine Capacity	8/10 rds	8/10 rds	8/10 rds

Specifications subject to change without notice.

Standard	Carry	Compact	10mm
.45 ACP	.45 ACP	.45 ACP	10mm
7.70"	7.10"	7.10"	8.6"
5.50"	5.50"	5.50"	5.50"
1.50"	1.50"	1.50"	1.50"
4.4"	3.9"	3.9"	5.0"
1 in 16"	1 in 16"	1 in 16"	1 in 16"
6.30"	5.70"	5.70"	5.70"
30.4 oz	30.4 oz	29.6 oz	39.4 oz
39.1 oz	N/A	N/A	44.4 oz
10 lbs	10 lbs	10 lbs	10 lbs
4.4 lbs	4.4 lbs	4.4 lbs	4.4 lbs
7.5 lbs	7.5 lbs	7.5 lbs	N/A
5 lbs	5 lbs	5 lbs	5 lbs
8/10 rds	6/8 rds	6/8 rds	8 rds

Specifications subject to change without notice.

12.3 P224 DAK DA/SA Parts Diagram

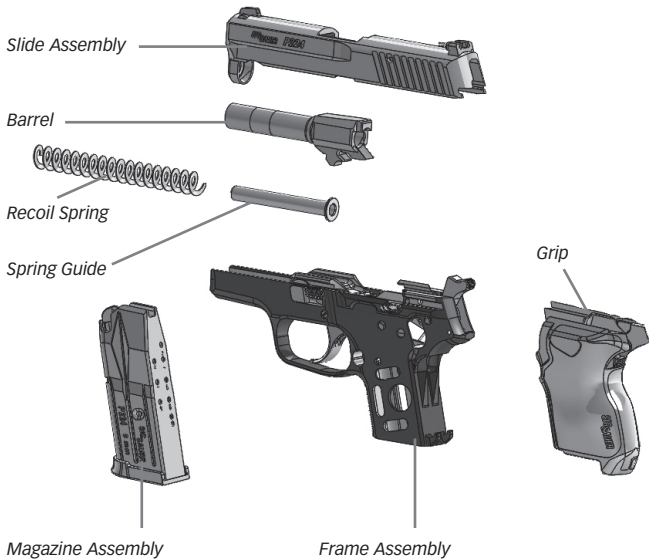

12.4 P224 DAK/DA/SA Technical Specifications

Caliber	9mm	357SIG	40S&W
Length, Overall	6.70"	6.70"	6.70"
Height, Overall	4.50"	4.50"	4.50"
Width, Overall DA/SA	1.50"	1.50"	1.50"
Width, Overall DAK	1.30"	1.30"	1.30"
Barrel Length	3.5"	3.5"	3.5"
Rifling Twist	1 in 10"	1 in 16"	1 in 15"
Rifling Grooves	6	6	6
Sight Radius	5.32"	5.32"	5.32"
Weight w/mag	25.4 oz	25.4 oz	25.4 oz
Trigger Pull Weight DA	10 lbs	10 lbs	10 lbs
Trigger Pull Weight SA	4.4 lbs	4.4 lbs	4.4 lbs
Trigger Pull Weight DAK	6.5 lbs	6.5 lbs	6.5 lbs
Magazine Capacity	11 rds	10 rds	10 rds

Specifications subject to change without notice.

12.5 P225 Parts Diagram

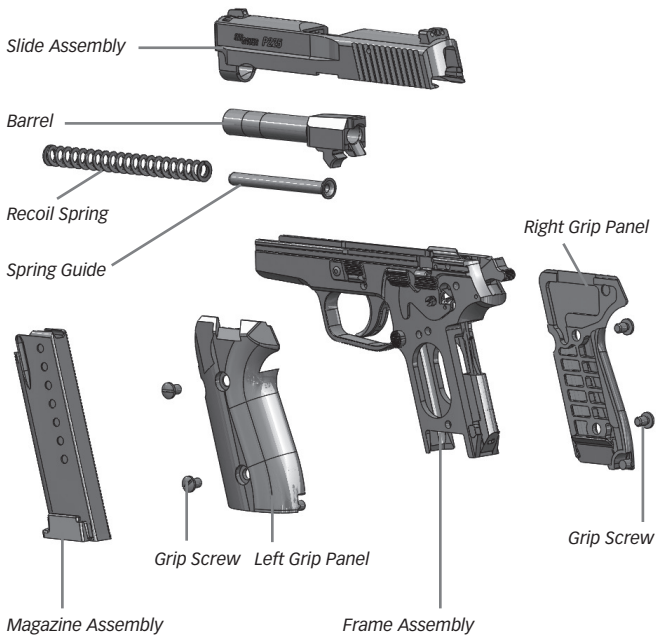

12.6 P225 Technical Specifications

Caliber	9mm
Length, Overall	6.90"
Height, Overall	5.20"
Width, Overall	1.26"
Barrel Length	3.6"
Rifling Twist	1 in 10"
Rifling Grooves	6
Sight Radius	5.20"
Weight w/mag	28.0 oz
Trigger Pull Weight DA	10 lbs
Trigger Pull Weight SA	4.4 lbs
Trigger Pull Weight DAK	6.5 lbs
Magazine Capacity	8 rds

Specifications subject to change without notice.

12.7 P226 Parts Diagram

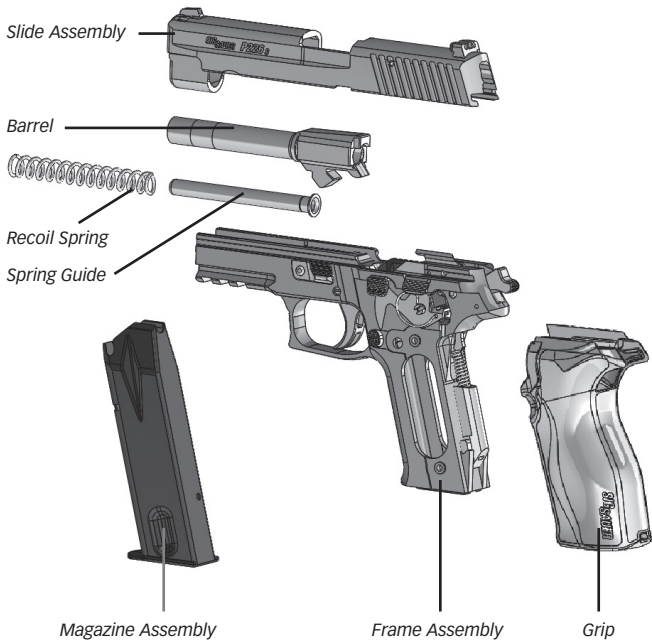

12.8 P226 Technical Specifications

Caliber	9mm	.40 S&W	.357 SIG
Length, Overall	7.70"	7.70"	7.70"
Length, Overall (Elite)	8.20"	8.20"	8.20"
Height, Overall	5.50"	5.50" 5	.50"
Width, Overall	1.50"	1.50"	1.50"
Width, Overall (Elite)	1.60"	1.60"	1.60"
Barrel Length	4.4"	4.4"	4.4"
Rifling Twist	1 in 10"	1 in 15"	1 in 16"
Rifling Grooves	6	6	6
Sight Radius	6.30"	6.30"	6.30"
Weight (alloy) w/mag	34.0 oz	34.0 oz	34.0 oz
Weight (stainless) w/mag	42.2 oz	42.2 oz	42.2 oz
Trigger Pull Weight DA	10 lbs	10 lbs	10 lbs
Trigger Pull Weight SA	4.4 lbs	4.4 lbs	4.4 lbs
Trigger Pull Weight DAK	6.5 lbs	6.5 lbs	6.5 lbs
Magazine Capacity	15 rds	12 rds	12 rds

Specifications subject to change without notice.

12.9 P227 Parts Diagram

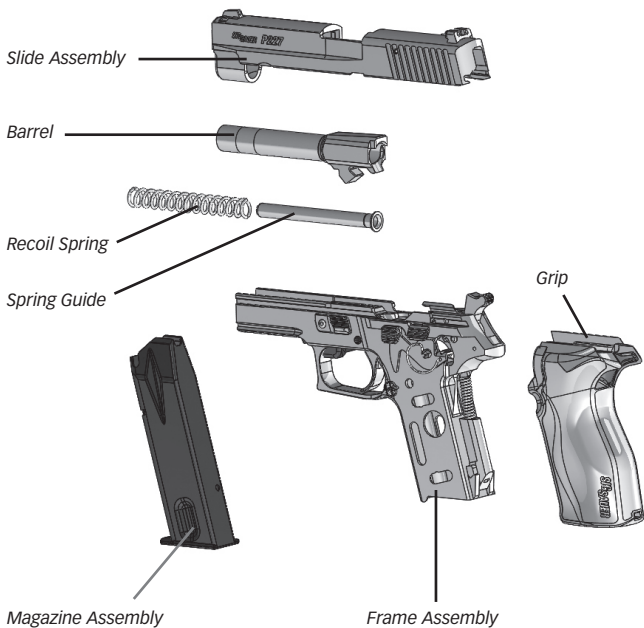

12.10 P227 Technical Specifications

P227 Type	Nitron	Carry	SAS Gen 2
Caliber	.45 ACP	.45 ACP	.45 ACP
Length, Overall	7.70"	7.10"	7.10"
Height, Overall	5.50"	5.50"	5.50"
Width, Overall	1.50"	1.50"	1.50"
Barrel Length	4.4"	3.9"	3.9"
Rifling Twist	1 in 16"	1 in 16"	1 in 16"
Sight Radius	6.3"	5.7"	5.7"
Weight w/mag	32.0 oz	30.5 oz	30.5 oz
Trigger pull weight DA	10 lbs	10 lbs	10 lbs
Trigger pull weight SA	4.4 lbs	4.4 lbs	4.4 lbs
Magazine Capacity	10 rds	10 rds	10 rds

Specifications subject to change without notice.

12.11 P229 Parts Diagram

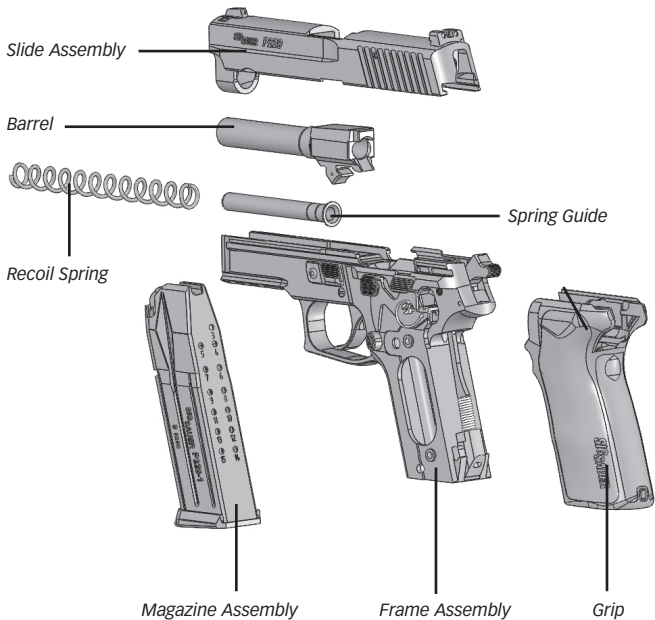

12.12 P229 Technical Specifications

Caliber	9mm	.40 S&W	357 SIG
Length, Overall	7.10"	7.10"	7.10"
Length, Overall (Elite)	7.60"	7.60"	7.60"
Height, Overall	5.10"	5.10"	5.10"
Width, Overall	1.50"	1.50"	1.50"
Width, Overall (Elite)	1.60"	1.60"	1.60"
Barrel Length	3.9"	3.9"	3.9"
Rifling Twist	1 in 10"	1 in 15"	1 in 16"
Rifling Grooves	6	6	6
Sight Radius	5.70"	5.70"	5.70"
Weight (alloy) w/mag	32.0 oz	32.0 oz	32.0 oz
Weight (stainless) w/mag	41.9 oz	41.9 oz	41.9 oz
Trigger Pull Weight DA	10 lbs	10 lbs	10 lbs
Trigger Pull Weight SA	4.4 lbs	4.4 lbs	4.4 lbs
Trigger Pull Weight DAK	6.5 lbs	6.5 lbs	6.5 lbs
Magazine Capacity	13 rds	12 rds	12 rds

Specifications subject to change without notice.

12.13 P229 Carry Parts Diagram

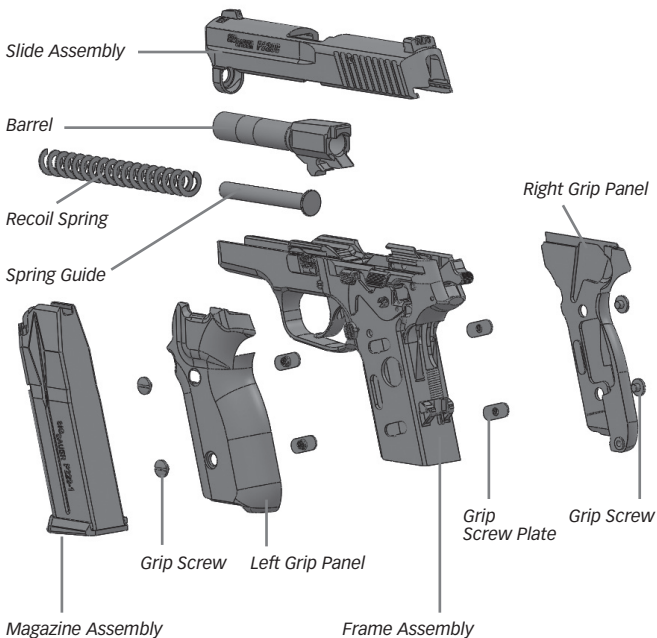

12.14 P229 Carry Technical Specifications

Caliber	.357 SIG	.40 S&W
Length, Overall	6.7"	6.7"
Height, Overall	5.4"	5.4"
Width, Overall DA/SA	1.3"	1.3"
Width, Overall DAK	1.3"	1.3"
Barrel Length	3.5"	3.5"
Rifling Twist	1:16 RH	1:16 LH
Rifling Grooves	6	6
Sight Radius	5.3"	5.3"
Weight w/mag	31.0 oz	31.0 oz
Trigger Pull Weight DA/SA	4.4-10 lbs	4.4-10 lbs
Magazine Capacity	12	12

Specifications subject to change without notice.

12.15 P239 Parts Diagram

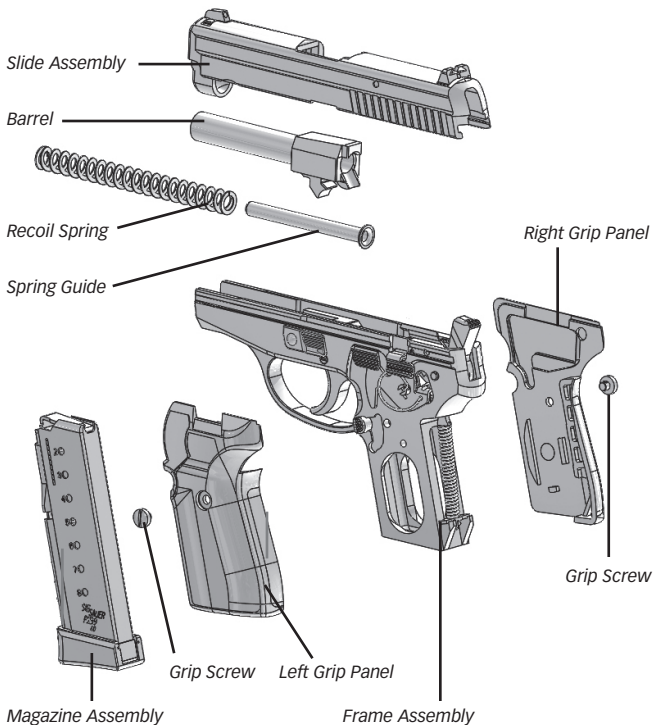

12.16 P239 Technical Specifications

Caliber	9mm	.40 S&W	.357 SIG
Length, Overall	6.60"	6.60"	6.60"
Height, Overall	5.2"	5.2"	5.2"
Width, Overall	1.20"	1.20"	1.20"
Barrel Length	3.6"	3.6"	3.6"
Rifling Twist	1 in 10"	1 in 15"	1 in 16"
Rifling Grooves	6	6	6
Sight Radius	5.20"	5.20"	5.20"
Weight (alloy) w/mag	29.5 oz	29.5 oz	29.5 oz
Trigger Pull Weight DA	10 lbs	10 lbs	10 lbs
Trigger Pull Weight SA	4.4 lbs	4.4 lbs	4.4 lbs
Trigger Pull Weight DAK	6.5 lbs	6.5 lbs	6.5 lbs
Magazine Capacity	8 rds	7 rds	7 rds

Specifications subject to change without notice.

Appendix A: Trigger Systems

There are three trigger systems common to all four models, double action only (DAO), double action Kellerman (DAK), and double action/ single action (DA/SA). A fourth system, single action only (SAO) is available in the P220 only.

DA refers to a system in which pulling the trigger accomplishes two actions, cocking the hammer and releasing it.

SA refers to a system in which the trigger only releases the hammer. Cocking is accomplished manually or by the motion of the slide during firing.

The DA/SA system has attributes of both. When loaded, and a round is chambered, the hammer remains cocked by the sear. The pistol may be fired by a short, light single action trigger pull or decocked by pressing the decocking lever down and releasing it. Once decocked, the pistol may be fired by a longer, heavier double action trigger pull. As the trigger is pulled, the hammer is moved back by a connecting link called the trigger bar. At a position near the cocked position, the trigger bar releases the hammer. The advantages of DA/SA are the long, deliberate trigger pull required to fire the first shot, which minimizes the chance of an accidental discharge, and the short, light trigger pull on subsequent shots, which promotes more accurate fire.

The DAO trigger pull is exactly the same for every shot. These pistols are double-strike capable. There is no decocking lever on DAO pistols.

The DAK is an improved DAO system named after its inventor, a SIG SAUER engineer. The DAK has a light double action pull, which allows for firing with the trigger in the fully released position or the alternate intermediate position. The DAK system is double-strike capable.

The fourth system, SAO is unique to the P220 category of pistols. Its advantage is more accurate fire through a light, short trigger pull. The hammer is cocked by the movement of the slide. An ambidextrous thumb safety is located on the frame. It positively blocks trigger and hammer motion to allow safe carry and handling when cocked. The safety may be engaged with the hammer cocked or uncocked. The safety does not block the slide when engaged, which allows loading and unloading with the safety on.

Appendix B: P220 SAO Supplemental Instructions

The SIG Sauer P220 SAO is a single action only pistol. This firearm incorporates many of the same safety features found in other SIG Sauer pistols, including the firing pin safety, hammer safety intercept notch, and disconnecter. The P220 SAO features an integrated thumb safety, located above and to the rear of the grip.

The thumb safety can be engaged with the hammer cocked or hammer forward. The thumb safety can not be engaged unless the slide is fully closed.

Push the thumb safety fully upward to engage. A white dot will be visible on the thumb safety. When engaged, the hammer is blocked, preventing it from falling when the trigger is pulled.

Always engage the thumb safety before loading and unloading the pistol. Keep the thumb safety engaged until ready to fire.

⚠ WARNING – SAFETY

The thumb safety must be engaged (in the UP position) until ready to fire. Failure to engage the manual safety can lead to accidental discharge, causing injury, death or damage to property.

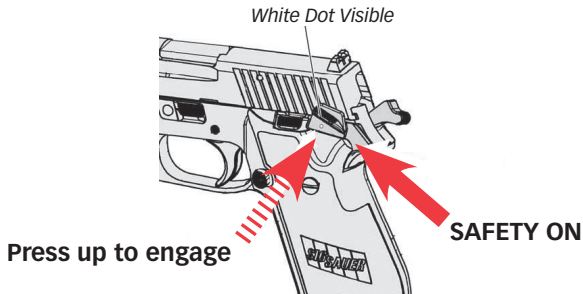

To disengage, depress the thumb safety fully downward. When the thumb safety is down, the hammer is free to fall when the trigger is pulled.

⚠ WARNING – SAFETY

After each discharge, the pistol is in the cocked and ready to fire condition. If you wish to interrupt the shooting session, you must unload the pistol.

Unloading the pistol

- Engage manual safety
- Remove magazine
- Lock slide to the rear
- Chamber and magazine well - visually and physically check clear of all ammunition and casings.
- Ease slide forward to closed position.
- Muzzle in safe direction.
- Release manual safety
- Squeeze trigger, allowing hammer to fall.

⚠ WARNING – SAFETY

Press down to engage

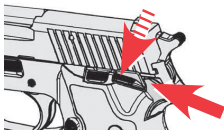

**SAFETY
ON**

Never lower the hammer by pulling the trigger and attempting to ease the hammer forward manually. Manually lowering the hammer is dangerous and prevents full application of the pistol's safety features. Accidental discharge could result, causing injury, death or damage to property.

Appendix C: SRT Supplemental Instructions

Thank you for purchasing our new Elite Series pistol with Short Reset Trigger (SRT) System. Please be advised that there is an additional step in field stripping your pistol equipped with an SRT system. Disregard procedure 8.1, steps 5 and 6 and follow the steps listed below:

- Pull back the slide slightly to disengage the slide catch lever. Hold the slide firmly and allow it to move forward slowly.
- As the slide reaches its closed position, decock the pistol. This will allow the SRT safety lever to completely retract so the slide can be fully removed from the frame.
- Now slip the complete assembly (comprised of slide, barrel, recoil spring and guide rod) forward and off the frame.

Should you need any further support in disassembling your SRT equipped pistol, please call our Customer Service Department at (603) 610-3000 ext 3.

SIG SAUER® Limited Lifetime Firearms Warranty

SIG SAUER® warrants that the enclosed firearm was originally manufactured free of defects in material, workmanship and mechanical function. For the lifetime of the original purchaser, SIG SAUER agrees to correct any defect in the firearm for the original purchaser by repair, adjustment or replacement, at SIG SAUER's option, with the same or comparable quality components (or by replacing the firearms at SIG SAUER's option); provided, however, that the firearm is returned unloaded and freight prepaid to:

**SIG SAUER
18 Industrial Drive
Exeter, NH 03833**

This limited warranty is null and void if the firearm has been misused, damaged (by accident or otherwise), fired with handloaded, reloaded or improper ammunition, fired with an obstruction in the barrel, damaged through failure to provide reasonable and necessary maintenance as described in the manual accompanying the firearm, or if unauthorized repair or any alteration, including of a cosmetic nature, has been performed on the firearm. This limited warranty does not apply to normal wear and tear of any parts. Subject to the foregoing, this limited warranty confers the right to have the covered firearm or its parts repaired, adjusted or replaced exclusively upon the original purchaser, which right is not transferable to any other person. No implied warranties of any kind are made herein and this warranty does not apply to any accessory items attached or appurtenant to the firearm. In no event shall SIG SAUER be liable for any incidental or consequential damages arising from or in connection with this limited warranty.

Notes:

Notes:

SIGSAUER[®]
when it counts[®]

www.sigsauer.com

**FOR PRODUCT SERVICE ON THIS MODEL,
PLEASE CALL (603) 610-3000 EXT. 1**

72 Pease Boulevard, Newington, NH 03801